

FS-RDTOWER Insert compatible with Return to Dark Tower[®]

incl. space for the Alliances[®] and Covenant[®] expansions



Assembly Instructions

The package contains eight single sheets.

After assembly the trays are put in up to three layers in the original game box.

Ordinary PVA glue is required when assembling each tray.

Please make sure you **dry-assemble** each tray correctly before gluing it together.

Please check www.foldedspace.com for general assembly tips.

FS-RDTOWER

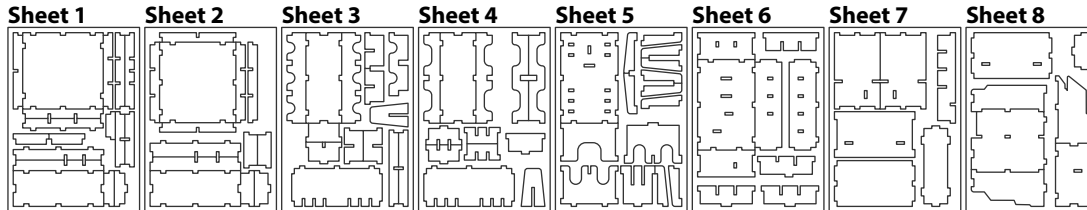
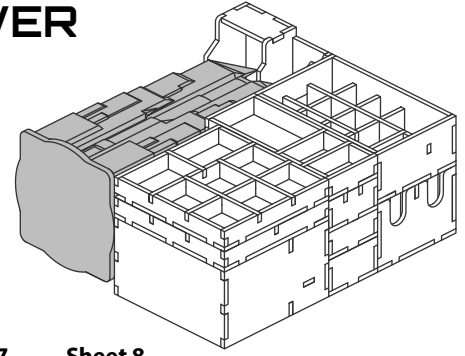

Tray 1

Sheet 1

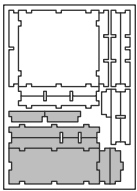

Step 1

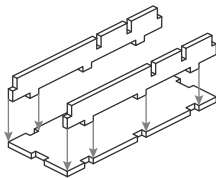

Step 2

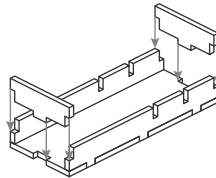

Step 3

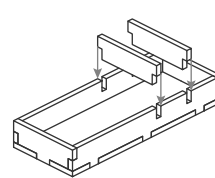

Finished tray

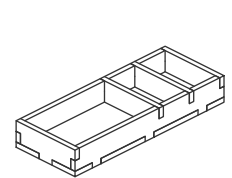

Tray 2

Sheet 2

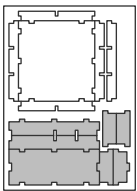

Step 1

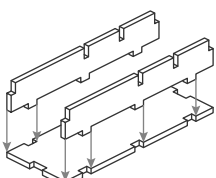

Step 2

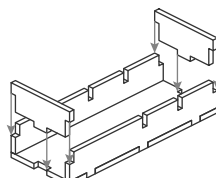

Step 3

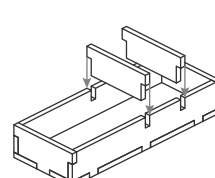

Finished tray

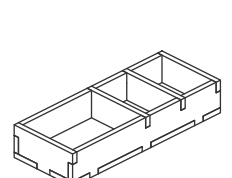

Tray 3

Sheet 2, 3

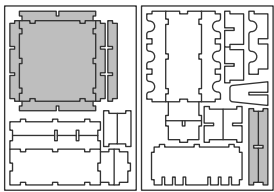

Step 1

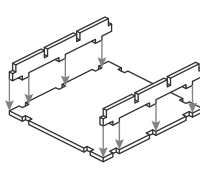

Step 2

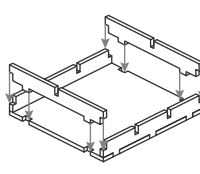

Step 3

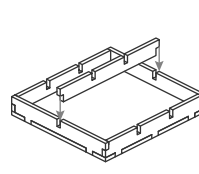

Step 4

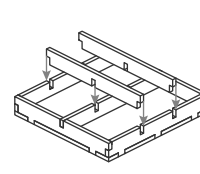

Finished tray

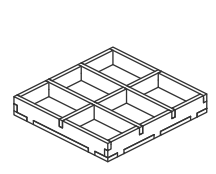

Tray 4

Sheet 1

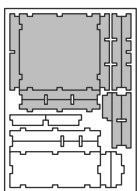

Step 1

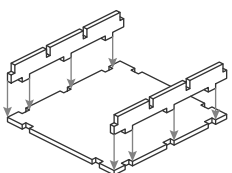

Step 2

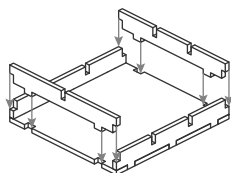

Step 3

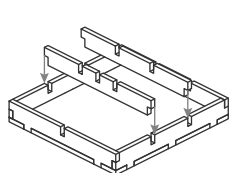

Step 4

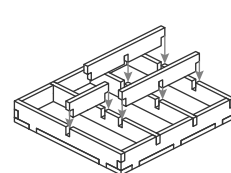

Finished tray

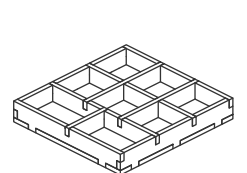

FS-RDTOWER Insert compatible with Return to Dark Tower[®]

incl. space for the Alliances[®] and Covenant[®] expansions



Tray 5

Sheet 4

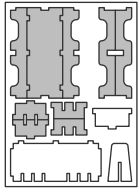

Step 1

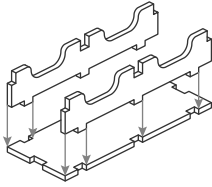

Step 2

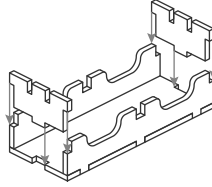

Step 3

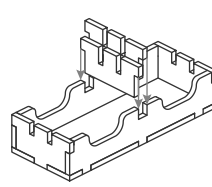

Step 4

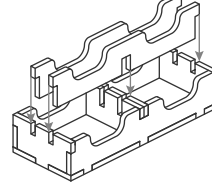

Finished tray

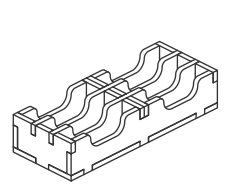

Tray 6

Sheet 4

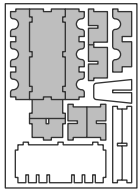

Step 1

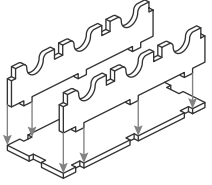

Step 2

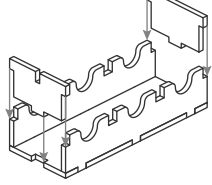

Step 3

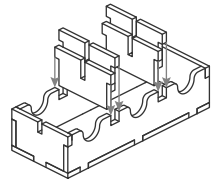

Step 4

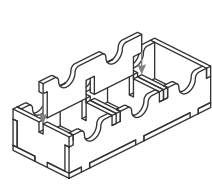

Finished tray

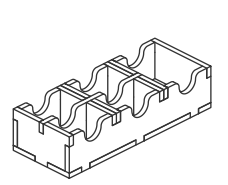

Tray 7

Sheet 7, 8

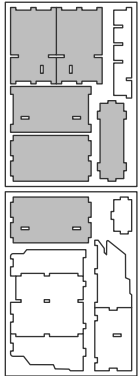

Step 1

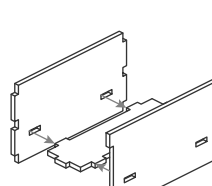

Step 2

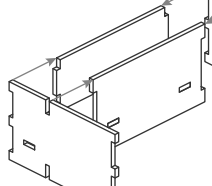

Step 3

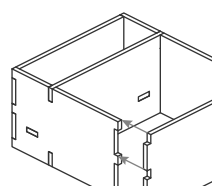

Finished tray

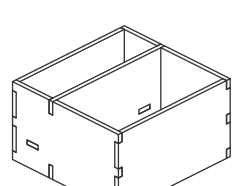

Tray 8

Sheet 4, 6, 7

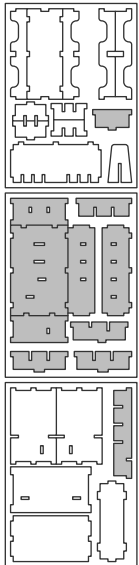

Step 1

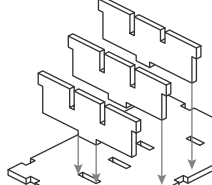

Step 2

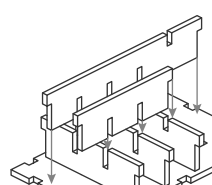

Step 3

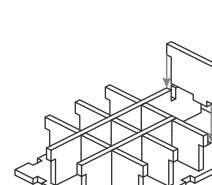

Step 4

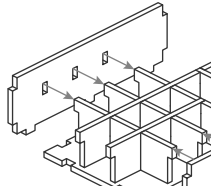

Step 5

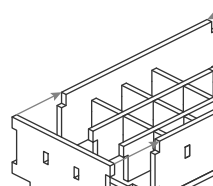

Finished Tray

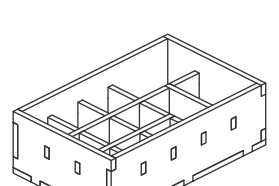

FS-RDTOWER Insert compatible with Return to Dark Tower[®]

incl. space for the Alliances[®] and Covenant[®] expansions



Tray 9

Sheet 3, 4, 5

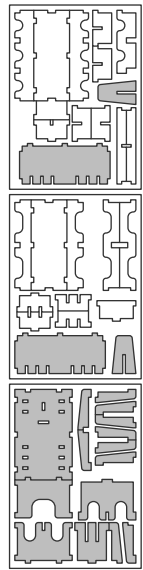

Step 1

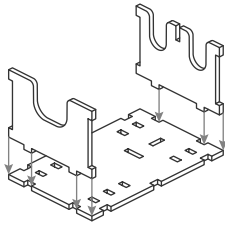

Step 2

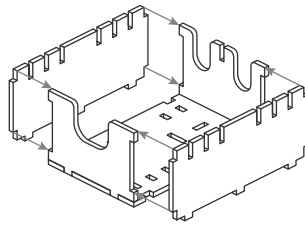

Step 3

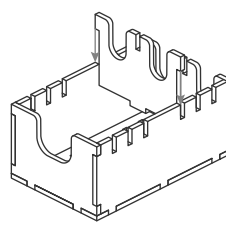

Step 4

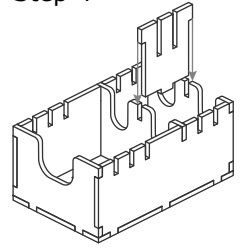

Step 5

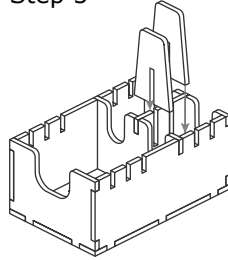

Step 6

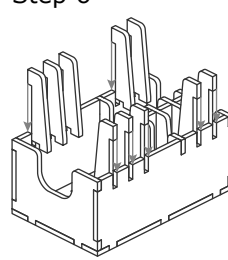

Finished Tray

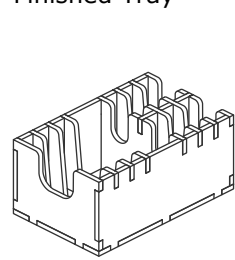

Tray 10

Sheet 8

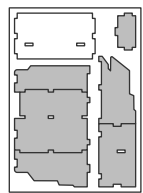

Step 1

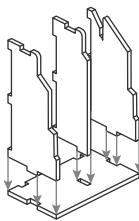

Step 2

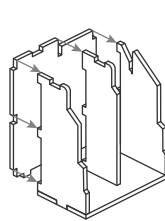

Step 3

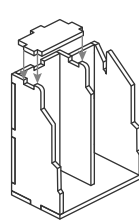

Finished tray

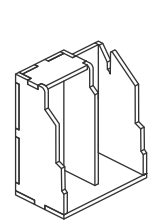

FS-RDTOWER

Please check www.foldedspace.com for photos of this insert in use.

Tray legend

- Tray 1 - wasteland, charge and advantage tracking tokens
- Tray 2 - spore & siege tree tokens, dungeon tokens, and foundation tiles, quarry & battlement tokens
- Tray 3 - spirit, warrior and influence tokens
- Tray 4 - skulls (regular, doom and power), offering tokens, and haggle die, protection tokens, guild markers & guild flags
- Tray 5 - virtue tiles
- Tray 6 - foe tokens
- Tray 7 - buildings & monument figures
- Tray 8 - quest markers, hero figures with bases, and skull bag & influence vessel
- Tray 9 - all card decks (card-back prints in the tray base indicate where each deck goes) & heroic action overlays (added to the slot for the monument cards)
- Tray 10 - filler tray for tower

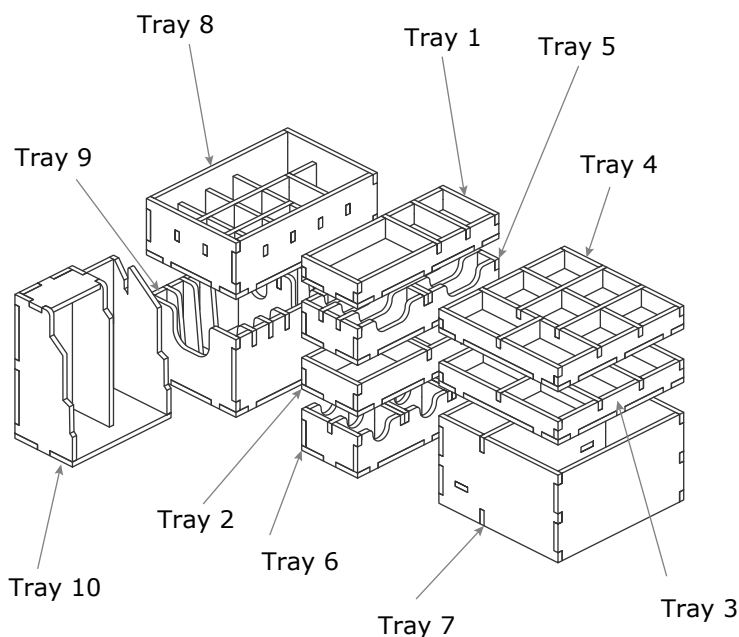

Tip: Keep the instructions in the bottom of your board game box as a reminder of how the insert fits together.