

FS-GLOSE Insert compatible with Gloomhaven Second Edition®

Assembly Instructions

The package contains 14 sheets: three double and eight single sheets.

After assembly the trays are put in up to seven layers in the original game box.

Ordinary PVA glue is required when assembling each tray.

Please make sure you **dry-assemble** each tray correctly before gluing it together.

Please check www.foldedspace.com for general assembly tips.



FS-GLOSE

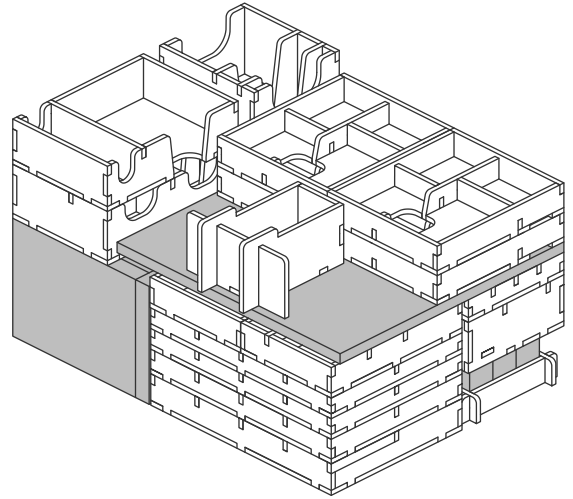

Sheet 1, 2 Sheet 3, 4 Sheet 5, 6 Sheet 7 Sheet 8

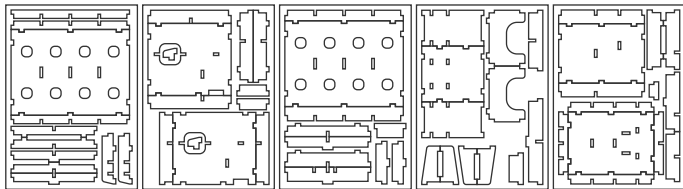

Sheet 9 Sheet 10 Sheet 11 Sheet 12 Sheet 13 Sheet 14

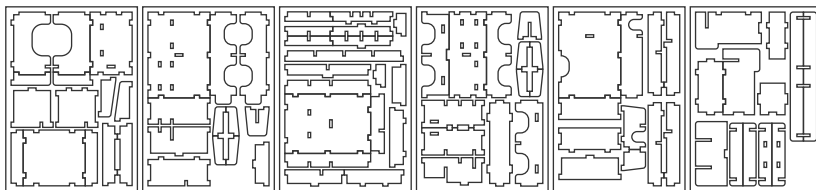

Tray 1

Sheet 9

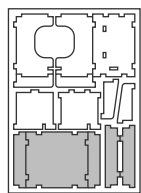

Step 1

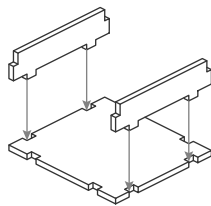

Step 2

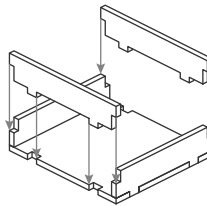

Finished tray

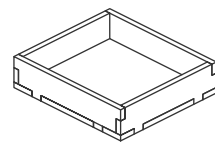

Tray 2

Sheet 13

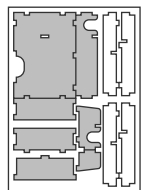

Step 1

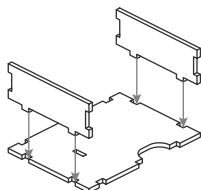

Step 2

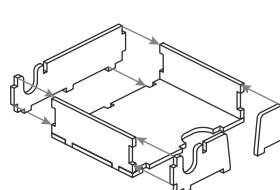

Step 3

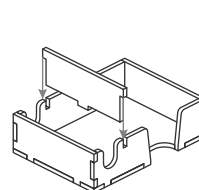

Finished tray

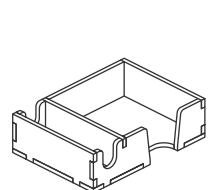

Tray 3a, b, c, d

(the trays are identical)

Sheet 1, 2, 3, 4, 5, 6, 13

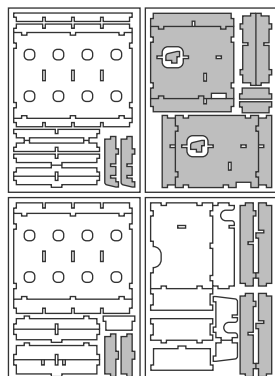

Step 1

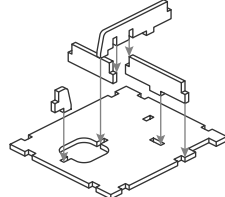

Step 2

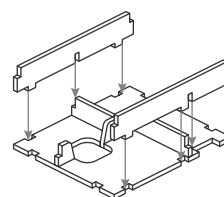

Step 3

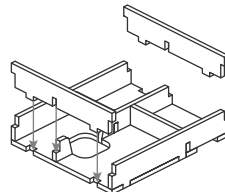

Finished tray

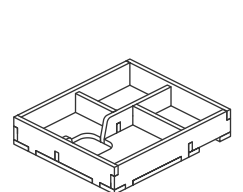

FS-GLOSE Insert compatible with Gloomhaven Second Edition®



Tray 4 Sheet 14

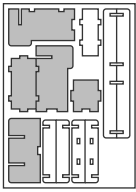

Step 1

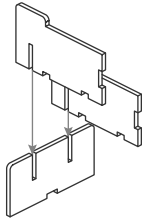

Step 2

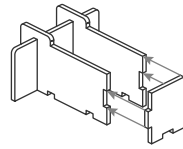

Step 3

(flip 180°)

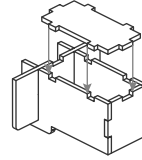

(flip 180°)



Finished tray

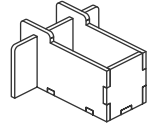

Tray 5 Sheet 7

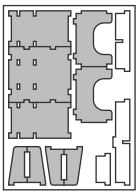

Step 1

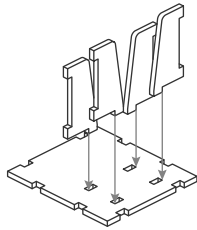

Step 2

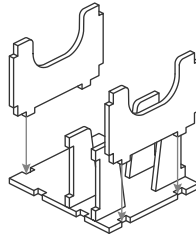

Step 3

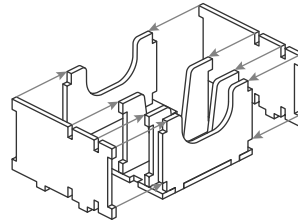

Finished tray

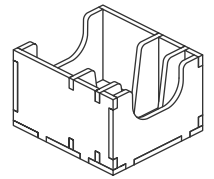

Tray 6 Sheet 14

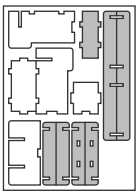

Step 1

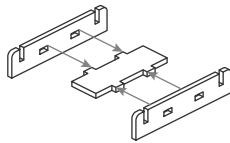

Step 2

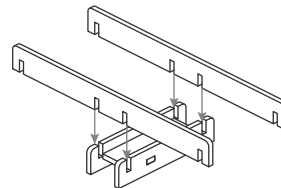

Step 3

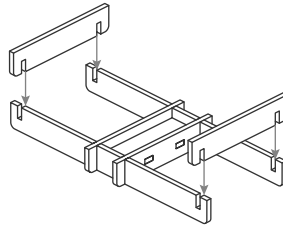

Finished tray

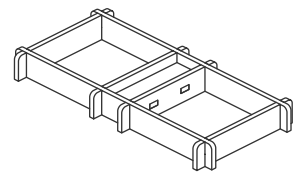

(flip 180°)



(flip 180°)



Tray 7a, b

Sheet 1,2

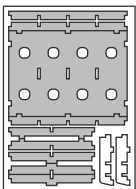

(the trays are identical)

Step 1

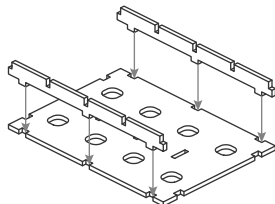

Step 2

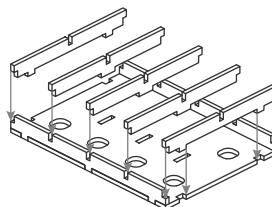

Step 3

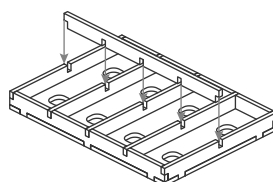

Finished tray

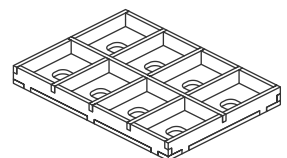

Note that the colour print has a gradient from dark to light. Make sure that you match the walls and dividers darkness levels to the tray base.

FS-GLOSE Insert compatible with Gloomhaven Second Edition®



Tray 8

Sheet 5, 6, 11

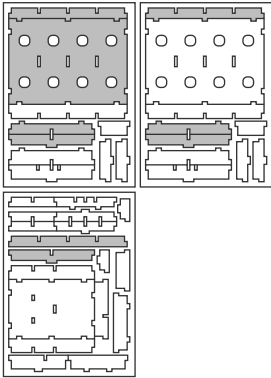

Step 1

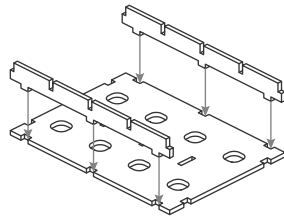

Step 2

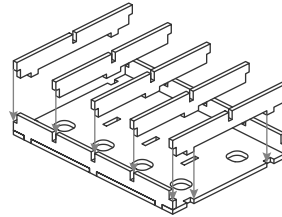

Step 3

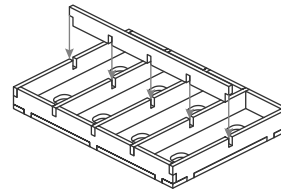

Finished tray

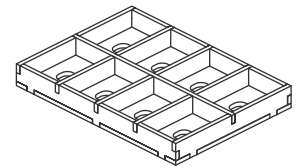

Like for Trays 7a & 7b, make sure that you match the darkness levels of the walls and dividers to the base.

Tray 9

Sheet 5, 6, 7

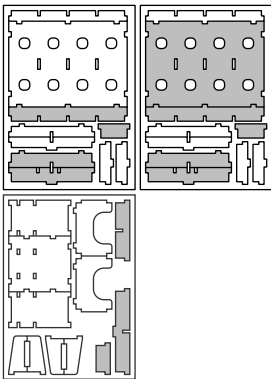

Step 1

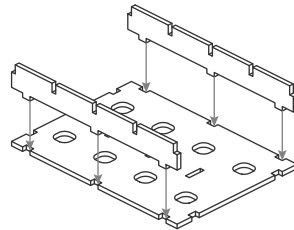

Step 2

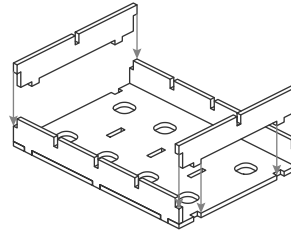

Step 3

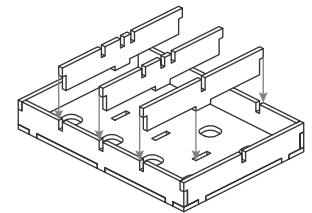

Step 4

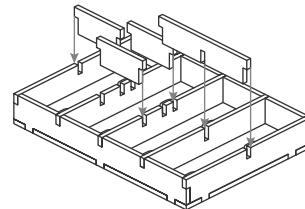

Finished tray

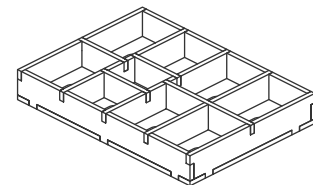

Like for Trays 7a & 7b, make sure that you match the darkness levels of the walls and dividers to the base.

Tray 10

Sheet 9

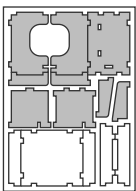

Step 1

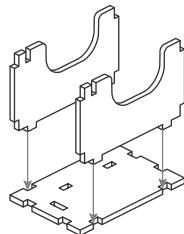

Step 2

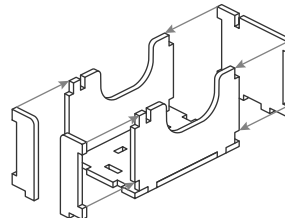

Step 3

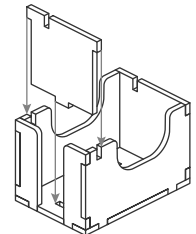

Step 4

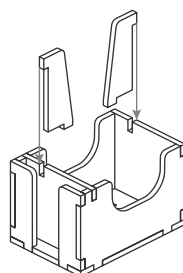

Finished tray

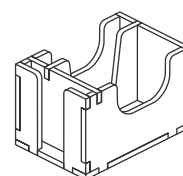

Tip: Keep the instructions in the bottom of your board game box as a reminder of how the insert fits together.

FS-GLOSE Insert compatible with Gloomhaven Second Edition®



Tray 11

Sheet 8, 10

Step 1

Step 2

Step 3

Step 4

Finished Tray

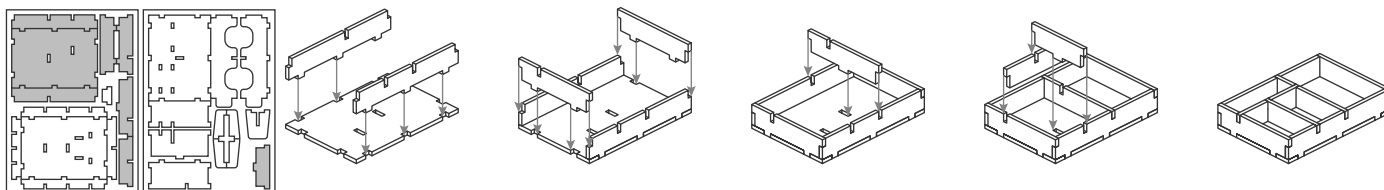

Tray 12

Sheet 11

Step 1

Step 2

Step 3

Step 4

Finished Tray

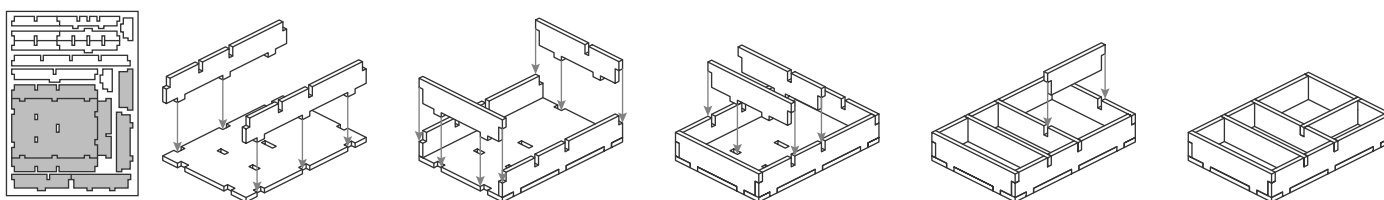

Tray 13

Sheet 10

Step 1

Step 2

Step 3

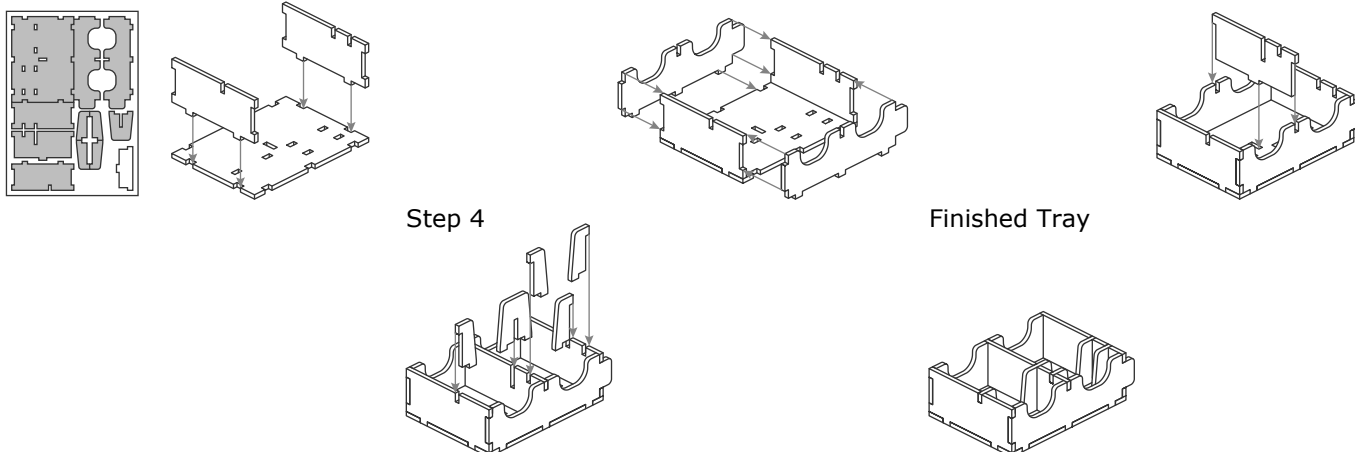

Tray 14

Sheet 8, 11

Step 1

Step 2

Step 3

Step 4

Step 5

Finished tray

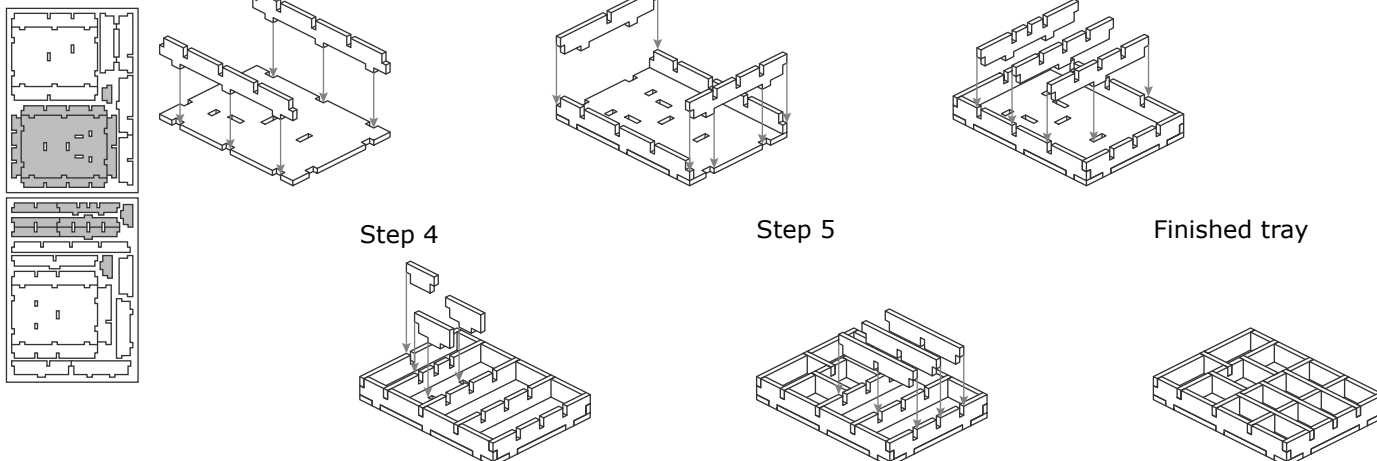

FS-GLOSE Insert compatible with Gloomhaven Second Edition®



Tray 15

Sheet 12

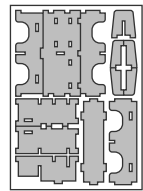

Step 1

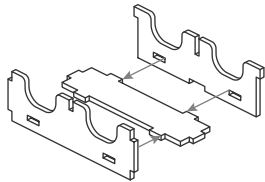

Step 2

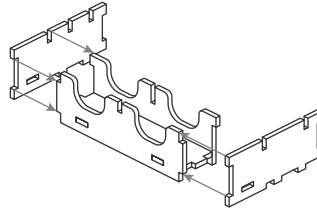

Step 3

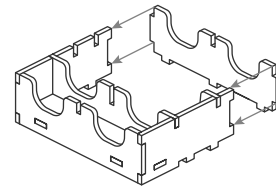

Step 4

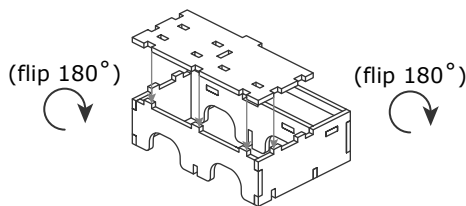

Step 5

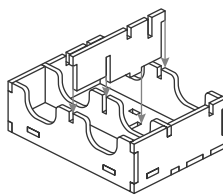

Step 6

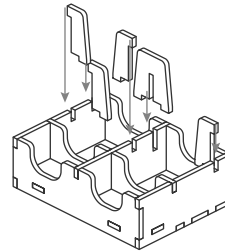

Finished tray

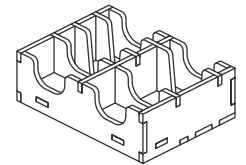

FS-GLOSE

Please check www.foldedspace.com
for photos of this insert in use.

Tray legend

Tray 1 - boss ability cards, boss initiative order token, boss standees, & the four item summon standees

Tray 2 - boss & monster stat cards & sleeves, and 1-hex overlay tiles*

Tray 3a, b, c, d - active character components (mat, character sheet, ability, character attack modifier, perk reminder cards & small cards from locked classes, character & summons standees, character mini, character initiative order token & other special tokens)

Tray 4 - filler/divider tray (if you have the Gloomhaven metal coins, you can fit the red pouch in this tray)

Tray 5 - city event, random room, random setup & player reference cards, and 3-hex overlay tiles*

Tray 6 - small tuckboxes for character miniatures

Tray 7a, b, 8, 9 - monster ability cards, monster initiative order tokens, & monster standees*

Tray 10 - road event cards, personal quest cards, and 3-hex overlay tiles*

Tray 11 - damage tokens, coin tokens and plastic bases

Tray 12 - 1-hex & 2-hex overlay tiles*

Tray 13 - item, random item, battle goal, and random scenario cards

Tray 14 - scenario aid tokens, condition tokens, and round marker & element tokens

Tray 15 - general attack modifier cards: red -1 modifier, monster, curse & bless, ally and character standard cards. Two additional slots for remaining 2-hex overlay tiles*

* refer to the printed art on the tray to organize the different tiles/standees/components

Note: Trays 3a, b, c, d & 4 are optional trays. These can only be used if the game's map tiles are stored elsewhere, such as in FS-GLOMAP, the Folded Space Map Archive folder for Gloomhaven (both first and second editions). By removing these five trays, you can store in their place all the map tiles in a single stack on top of the map board, without any lid lift.

FS-GLOSE Insert compatible with Gloomhaven Second Edition®



FS-GLOSE

Please check www.foldedspace.com
for photos of this insert in use.

Top Layer

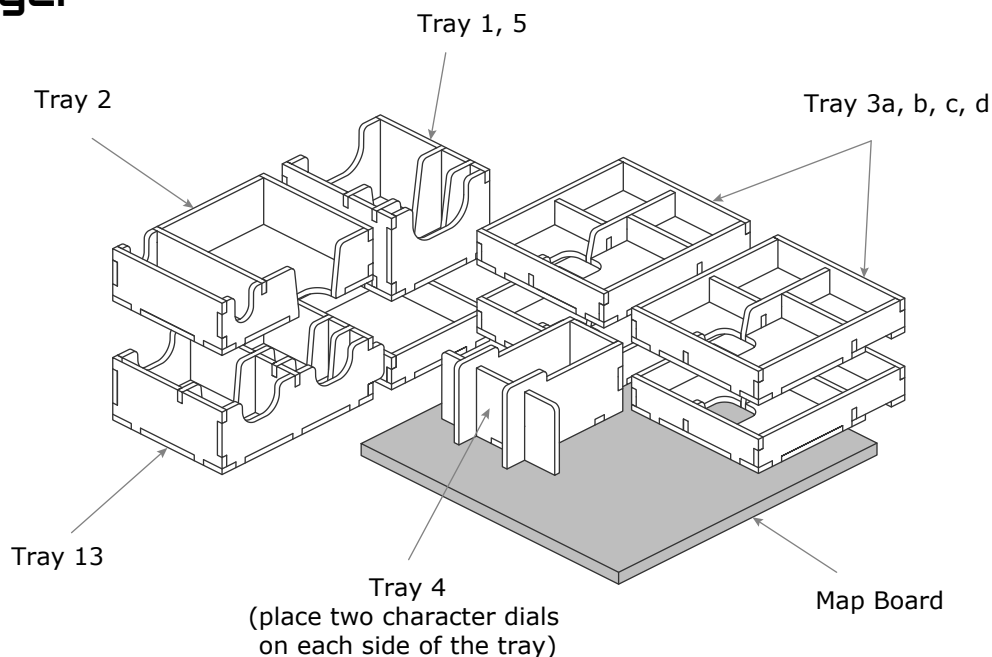

Bottom Layer

Large character tuckboxes*

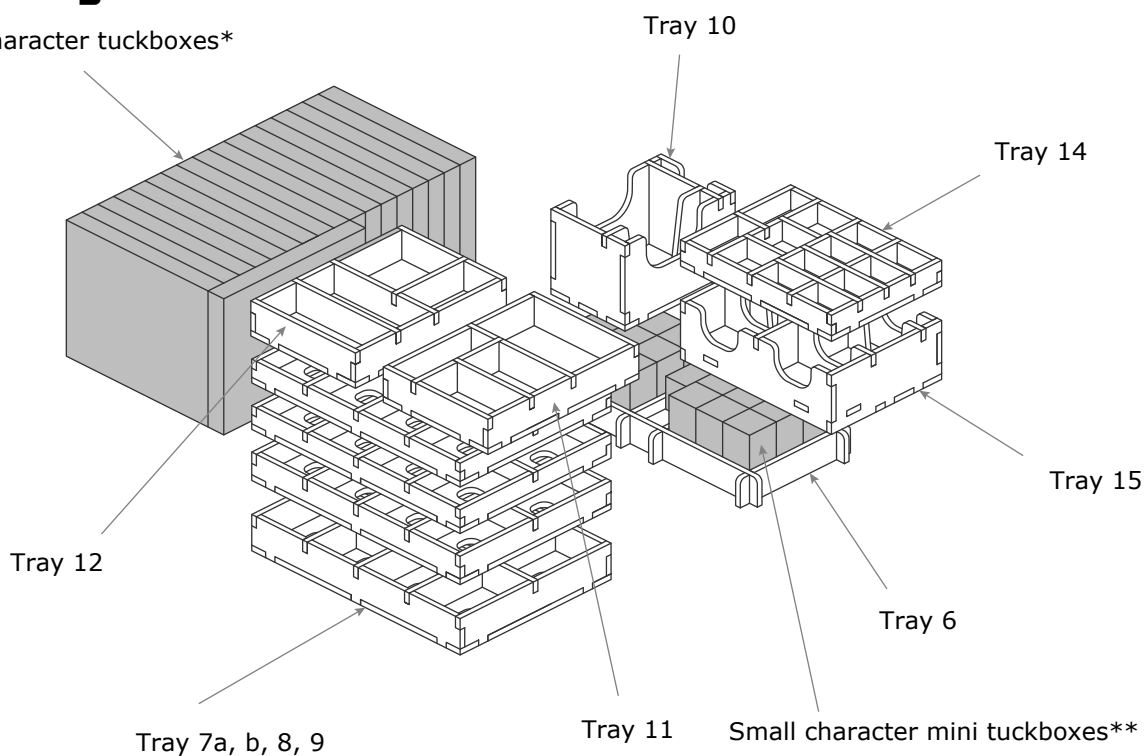

* one of the large tuckboxes should be placed perpendicular to the other boxes and aligned with the monster trays in the box.

** 18 of the small mini tuckboxes go into the square empty spaces in the tray. The last box goes in the middle where there is a base, and should be put on its side.